

Drop-In Drop-in refrigerated well, static with fan (3 GN container capacity)

ITEM # _____

MODEL # _____

NAME # _____

SIS # _____

AIA # _____

341042 (DIIC3)

 Drop-in refrigerated well,
 static with fan (3 GN
 container capacity)

Short Form Specification

Item No.

Designed to be positioned in flush installation providing improved cleanability and suitable for modern design installations. Designed to serve the food in gastronorm containers with a maximum height of 150mm. Food introduced at the correct temperature maintains its core temperature according to Afnor Standards. Automatic defrosting guarantees evaporators clearance and efficient well cooling. Digital control with temperature display with precise adjustment (0,1°C). Fully compliant HACCP digital controls include visible alarms. A constant flow of cold air circulating through the containers guarantees the correct food temperatures. Temperature uniformity and fast cool down times are guaranteed thanks to powerful radial booster fans. Cylindrical stainless steel air diffusers provides a constant air circulation. 84% faster cool down time (than static refrigerated well) reduces energy consumption by allowing the operator to switch the machines on only when needed. Wells in 304 AISI stainless steel with rounded corners to facilitate cleaning operations. The well is also equipped with a drain hole. High-density expanded polyurethane foam with cyclopentane guarantees excellent well insulation to reduce energy dispersion. R290 refrigerant gas (GWP=3) to reduce environmental impact and increase cooling efficiency. The bottom is equipped with copper tubes to ensure proper cooling, with this system the air touches the cold surface and gets cooled. Then cooled air is being distributed with radial booster fans.

Main Features

- Suitable for GN 1/1 containers with a maximum height of 150 mm.
- CB and CE certified by a third party notified body.
- Designed to be positioned in flush installation providing improved cleanability and suitable for modern design installations.
- Available drop-in dimensions: 2, 3, 4, 5, 6 GN.
- Designed to serve the food in gastronorm containers.
- Precise temperature control and setting at 0,1°C .
- As standard the product comes with digitally controlled thermostat which is in line of HACCP norms and provides visual alarm as a warning of the increasing or decreasing temperatures.
- Food introduced at the correct temperature maintains its core temperature according to Afnor Standards.
- Automatic defrosting guarantees evaporators clearance and efficient well cooling.
- Remote version is available.
- A constant flow of cold air circulating through the containers guarantees the correct food temperatures. Temperature uniformity and fast cool down times are guaranteed thanks to powerful radial booster fans. Cylindrical stainless steel air diffusers provides a constant air circulation.

Construction

- Well bottom is inclined to facilitate water drainage.
- Well in 304 AISI stainless steel with rounded corners to facilitate cleaning operations. The well is also equipped with a drain hole.
- Electronic control with temperature display.
- IPx2 water protection.
- The bottom is equipped with copper tubes to ensure proper cooling, with this system the air touches the cold surface and gets cooled. Then cooled air is being distributed with radial booster fans.

Sustainability



- Hydrocarbon refrigerant gas R290 for the lowest environmental impact (GWP=3) - CFC and HCFC free.
- High-density expanded polyurethane foam with cyclopentane guarantees excellent well insulation to reduce energy dispersion.
- 84% faster cool down time (than static refrigerated well) reduces energy consumption by allowing the operator to switch the machines on only when needed.

APPROVAL: _____

Rear side

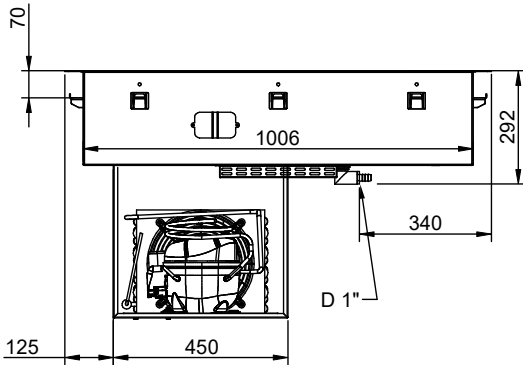

Side

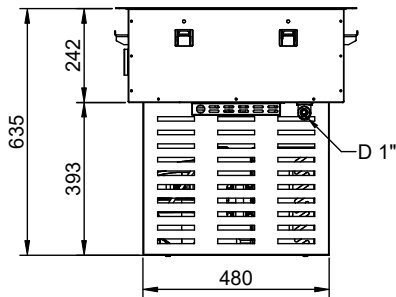

D = Drain
EI = Electrical inlet (power)

Top

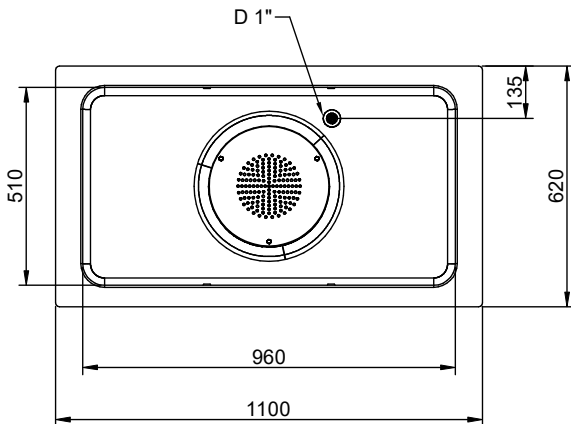

Electric

Supply voltage: 220-240 V/1N ph/50 Hz
Electrical power, max: 0.57 kW

Water:

Water drain outlet size: 1"

Key Information:

External dimensions,
Width: 1100 mm
External dimensions,
Depth: 620 mm
External dimensions,
Height: 595 mm
Net weight: 51.3 kg
Shipping weight: 65.7 kg
Shipping height: 920 mm
Shipping width: 660 mm
Shipping depth: 1140 mm
Shipping volume: 0.69 m³
Set temperature: -10 / 0 °C

Refrigeration Data

Refrigerant type: R290

Sustainability

Noise level: 62 dBA

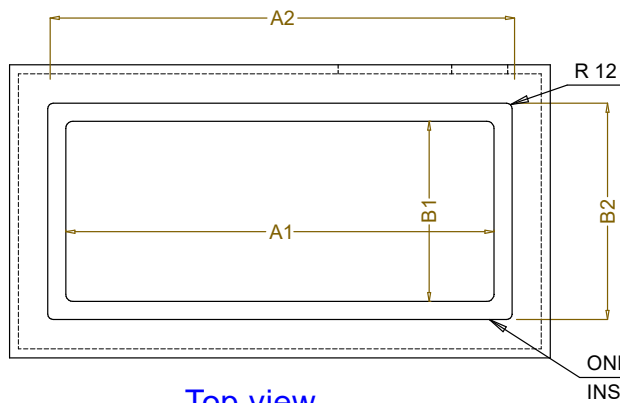

CAPACITY	CUTOUT		LOWERING FOR FLUSH INSTALLATION		C	K
	A1	B1	A2	B2		
2GN	700	580	774	624	880	470
3GN	1030		1104		1200	
4GN	1350		1424		1530	
5GN	1670		1744		1850	
6GN	2000		2074		2180	

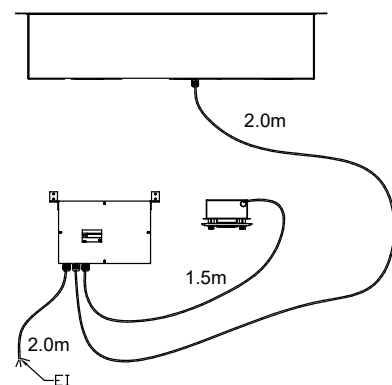

595T01R00 - COLD STATIC WELL WITH FAN